



Photoelectric sensors  
W9-3, Through-beam photoelectric sensor

WSE9M4-3P3430



Type > [WSE9M4-3P3430](#)  
Part No. > [1054435](#)



Illustration may differ

**At a glance**

- High-performance through-beam sensor in ultra-rugged VISTAL™ housing
- PinPoint LED for highly visible and precise light spot
- Variable mounting with M4 hole pattern
- Wide range of connection options

**Your benefits**

- Rugged VISTAL™ housing provides reliable installation and operation
- Reliable object detection in all situations using best-in-class performance
- Quick and easy alignment with reliable object detection due to the highly visible PinPoint light spot
- M4 slotted hole mounting for multiple mounting possibilities
- One housing with a wide range of options makes machine integration easy
- Variety of accessories for simple mounting



**Features**

Sensor/detection principle:	Through-beam photoelectric sensor
Dimensions (W x H x D):	12.2 mm x 52.2 mm x 23.6 mm
Housing design (light emission):	Rectangular
Mounting hole:	M4
Sensing range max.:	0 m ... 10 m
Sensing range:	0 m ... 7 m
Type of light:	Visible red light
Light source:	PinPoint LED <sup>1)</sup>
Adjustment:	No adjustment
Light spot size (distance):	Ø 25 mm (1 m)

<sup>1)</sup> Average service life of 100,000 h at T<sub>A</sub> = +25 °C

**Mechanics/electronics**

Supply voltage:	10 V DC ... 30 V DC <sup>1)</sup>
Ripple:	< 5 Vpp <sup>2)</sup>
Power consumption:	≤ 30 mA <sup>3)</sup>
Output type:	PNP <sup>4)</sup>
Switching mode:	Light/dark switching <sup>5)</sup>
Output current I <sub>max.</sub> :	≤ 100 mA <sup>6)</sup>
Response time:	< 0.5 ms <sup>7)</sup>

Switching frequency:	1,000 Hz <sup>8)</sup>
Connection type:	Cable with connector M12, 4-pin, 120 mm <sup>9)</sup>
Conductor cross-section:	0.14 mm <sup>2</sup>
Circuit protection:::	A, B, C <sup>10)</sup> <sup>11)</sup> <sup>12)</sup>
Protection class:	III
Weight:	80 g
Polarisation filter:	-
Optics material:	PMMA
Enclosure rating:	IP 66 IP 67 IP 69K
Test input sender off:	Sender off
Ambient operating temperature:	-40 °C ... +60 °C
Ambient storage temperature:	-40 °C ... +75 °C
Part number of individual components:	Receiver, WE9M4-3P3430, 2060502, Sender, WS9M4-3D3430, 2060501
UL File No.:	NRKH.E181493
Housing material:	Plastic, VISTAL

<sup>1)</sup> Limit values, operation in short-circuit protected network max. 8 A    <sup>2)</sup> May not exceed or fall short of  $V_S$  tolerances    <sup>3)</sup> Without load    <sup>4) 5)</sup> Q = light-switching    <sup>6)</sup> As of  
 Tu 50 °C, a max. load current  $I_{max.} = 50$  mA is permitted    <sup>7)</sup> Signal transit time with resistive load    <sup>8)</sup> With light/dark ratio 1:1    <sup>9)</sup> Do not bend below 0 °C    <sup>10)</sup> A =  $V_S$   
 connections reverse-polarity protected    <sup>11)</sup> B = inputs and output reverse-polarity protected    <sup>12)</sup> C = interference suppression

## Dimensional drawing

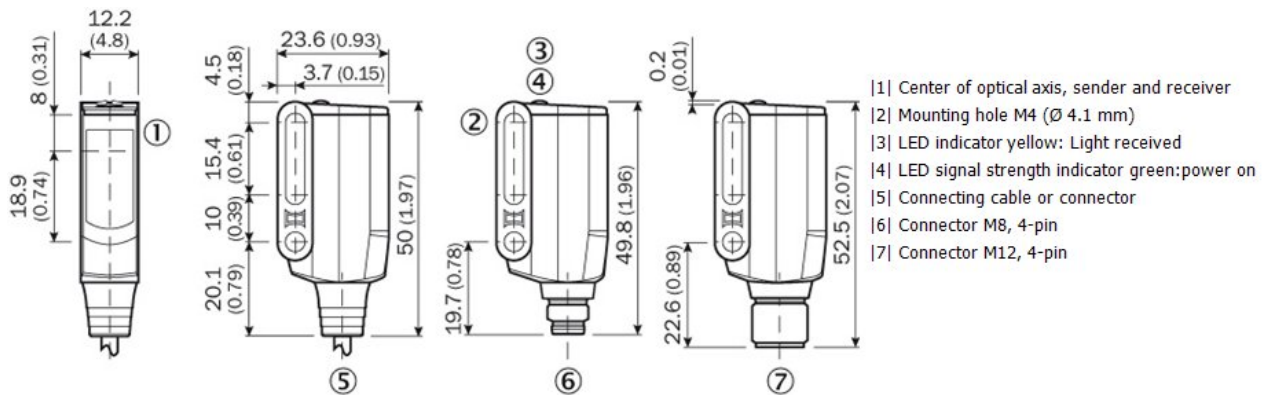

Adjustments possible

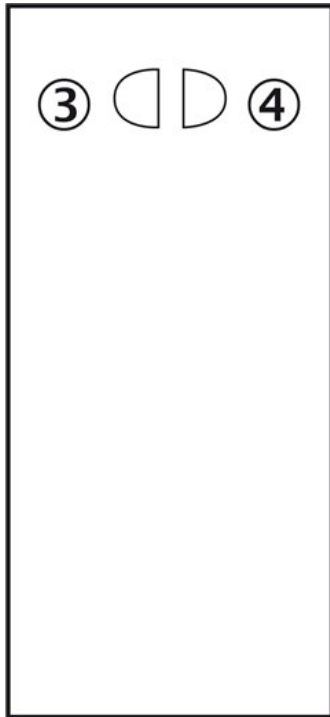

|3| LED indicator yellow: Light received  
|4| LED signal strength indicator green:power on

Connection diagram

①

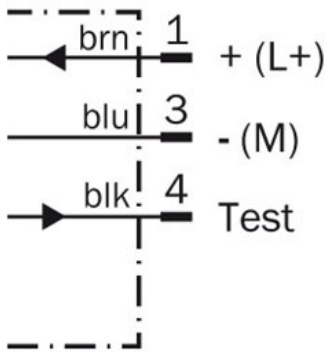

②

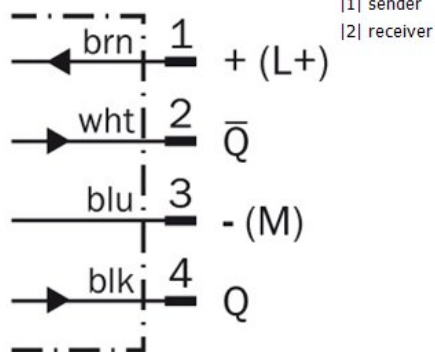

## Characteristic curve

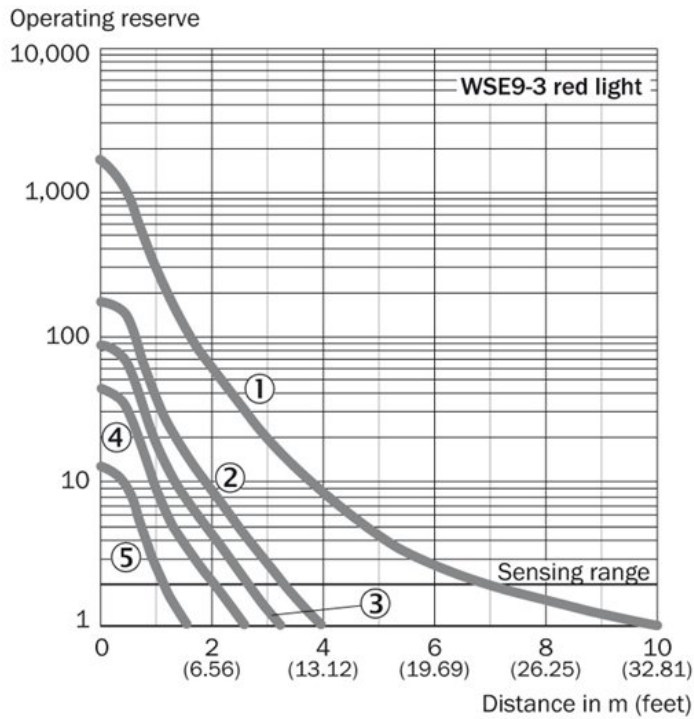

- [1] Without masks
- [2] With slotted mask, width 2.0 mm
- [3] With slotted mask, width 1.5 mm
- [4] With slotted mask, width 1.0 mm
- [5] With slotted mask, width 0.5 mm

## Sensing range diagram

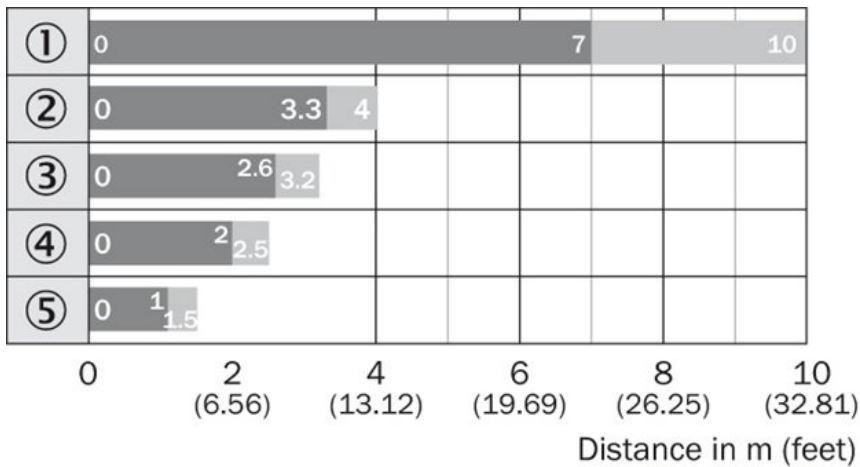

- [1] Without masks
- [2] With slotted mask, width 2.0 mm
- [3] With slotted mask, width 1.5 mm
- [4] With slotted mask, width 1.0 mm
- [5] With slotted mask, width 0.5 mm

■ Sensing range      ■ Sensing range, max. typ.

## Connection type

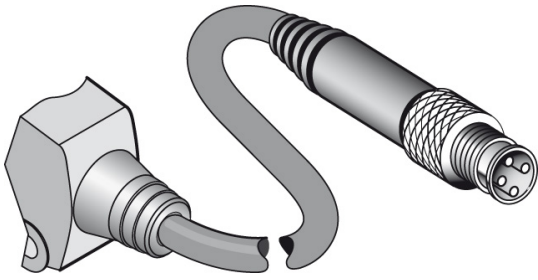

## Light spot size

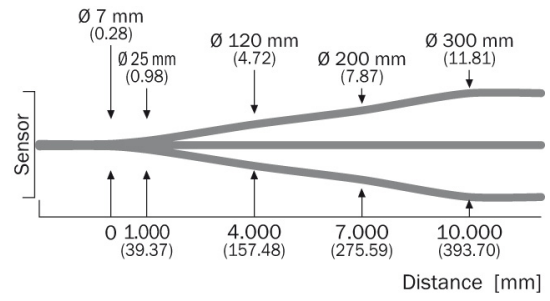

**Australia**

Phone +61 3 9457 0600  
1800 33 48 02 – tollfree  
E-Mail sales@sick.com.au

**Belgium/Luxembourg**

Phone +32 (0)2 466 55 66  
E-Mail info@sick.be

**Brasil**

Phone +55 11 3215-4900  
E-Mail marketing@sick.com.br

**Canada**

Phone +1 905 771 14 44  
E-Mail information@sick.com

**Česká republika**

Phone +420 2 57 91 18 50  
E-Mail sick@sick.cz

**China**

Phone +86 4000 121 000  
E-Mail info.china@sick.net.cn  
Phone +852-2153 6300  
E-Mail ghk@sick.com.hk

**Danmark**

Phone +45 45 82 64 00  
E-Mail sick@sick.dk

**Deutschland**

Phone +49 211 5301-301  
E-Mail info@sick.de

**España**

Phone +34 93 480 31 00  
E-Mail info@sick.es

**France**

Phone +33 1 64 62 35 00  
E-Mail info@sick.fr

**Great Britain**

Phone +44 (0)1727 831121  
E-Mail info@sick.co.uk

**India**

Phone +91-22-4033 8333  
E-Mail info@sick-india.com

**Israel**

Phone +972-4-6881000  
E-Mail info@sick-sensors.com

**Italia**

Phone +39 02 27 43 41  
E-Mail info@sick.it

**Japan**

Phone +81 (0)3 5309 2112  
E-Mail support@sick.jp

**Magyarország**

Phone +36 1 371 2680  
E-Mail office@sick.hu

**Nederland**

Phone +31 (0)30 229 25 44  
E-Mail info@sick.nl

**Norge**

Phone +47 67 81 50 00  
E-Mail sick@sick.no

**Österreich**

Phone +43 (0)22 36 62 28 8-0  
E-Mail office@sick.at

**Polska**

Phone +48 22 837 40 50  
E-Mail info@sick.pl

**România**

Phone +40 356 171 120  
E-Mail office@sick.ro

**Russia**

Phone +7-495-775-05-30  
E-Mail info@sick.ru

**Schweiz**

Phone +41 41 619 29 39  
E-Mail contact@sick.ch

**Singapore**

Phone +65 6744 3732  
E-Mail sales.gsg@sick.com

**Slovenija**

Phone +386 (0)1-47 69 990  
E-Mail office@sick.si

**South Africa**

Phone +27 11 472 3733  
E-Mail info@sickautomation.co.za

**South Korea**

Phone +82 2 786 6321/4  
E-Mail info@sickkorea.net

**Suomi**

Phone +358-9-25 15 800  
E-Mail sick@sick.fi

**Sverige**

Phone +46 10 110 10 00  
E-Mail info@sick.se

**Taiwan**

Phone +886 2 2375-6288  
E-Mail sales@sick.com.tw

**Türkiye**

Phone +90 (216) 528 50 00  
E-Mail info@sick.com.tr

**United Arab Emirates**

Phone +971 (0) 4 88 65 878  
E-Mail info@sick.ae

**USA/México**

Phone +1(952) 941-6780  
1 (800) 325-7425 – tollfree  
E-Mail info@sickusa.com

More representatives and agencies  
at [www.sick.com](http://www.sick.com)